



protect. teach. love.

Extreme Weather Pet Door™

Installation Guide for Small, Medium and Large

Please read this entire guide before beginning.



Model Numbers: PPA00-10984, PPA00-10985, PPA00-10986

Important Safety Information

Explanation of Attention Words and Symbols used in this guide



This is the safety alert symbol. It is used to alert you to potential personal injury hazards. Obey all safety messages that follow this symbol to avoid possible injury or death.

⚠ WARNING

WARNING indicates a hazardous situation which, if not avoided, could result in death or serious injury.

⚠ CAUTION

CAUTION, used with the safety alert symbol, indicates a hazardous situation which, if not avoided, could result in minor or moderate injury.

NOTICE

NOTICE is used to address safe use practices not related to personal injury.

⚠ WARNING

- When children are present in the home, it is important to consider the pet door during child proofing activities, the pet door may be misused by a child resulting in the child accessing potential hazards that may be on the other side of the pet door. Purchasers/Homeowners with swimming pools should ensure that the pet door is monitored at all times and that the swimming pool has adequate barriers to entry. If a new hazard is created inside or outside of your home, which may be accessed through the pet door, Radio Systems® Corporation recommends that you properly guard access to the hazard or remove the pet door. The closing panel or lock, if applicable, is provided for aesthetic and energy efficiency purposes and is not intended as a security device. Radio Systems® Corporation will not be liable for unintended use and the purchaser of this product accepts full responsibility for oversight of the opening it creates.
- Power Tools. Risk of severe injury; follow all safety instructions for power tools. Be sure to always wear safety goggles.

⚠ CAUTION

- The user, prior to installation, must become familiar with all building codes that may affect the installation of the pet door and determine, along with a licensed contractor, its suitability in a given installation. This pet door is not a fire door. It is important for the owner and contractor to consider any risks that may be present inside or outside of the pet door, and any risks that may be created by subsequent changes to your property and how they may relate to the existence and use, including misuse of the pet door.
- Be sure to use heavy scissors for cutting the core covers.
- If cutting a metal surface, be aware of sharp edges to prevent injury.

NOTICE

- Keep these instructions with important papers; be sure to transfer these instructions to the new owner of the property.
- If painting the pet door, it is recommended to paint it prior to installation. For best results, use a primer for plastics before applying paint.
- If homeowner's door or other application is not level, the pet door must be marked level to swing properly.
- Cut out correct size template. For the Large no cutting is required. If installing in a wall, reduce cut-out width by 1" for the Small and Medium. For the Large, reduce cut-out width by 1" and cut-out height by 1".
- When applying cutting template there should be a minimum of 3" between the bottom and sides of the door and the outer edge of the template to maintain the structural integrity of the door.
- Make sure there is nothing underneath the door where you will be drilling the holes or cutting out opening.
- Use a manual screwdriver to tighten screws. Do not overtighten. Overtightening can strip the screws or warp the pet door frame.

Thank you for choosing the PetSafe® brand. You and your pet deserve a companionship that includes memorable moments and a shared understanding together. Our products and training tools promote a lifestyle of protection, teaching, and love—essentials that influence memories for a lifetime. If you have any questions about our products or training your pet, please visit our website at www.petsafe.net or contact our Customer Care Center at **1-800-732-2677**.

PRODUCT WARRANTY

To get the most protection out of your warranty, please register your product within 30 days at www.petsafe.net. By registering and keeping your receipt, you will enjoy the product's full warranty and should you ever need to call the Customer Care Center, we will be able to help you faster. Most importantly, PetSafe® will never give or sell your valuable information to anyone. Complete warranty information is available online at www.petsafe.net.

Kit Includes

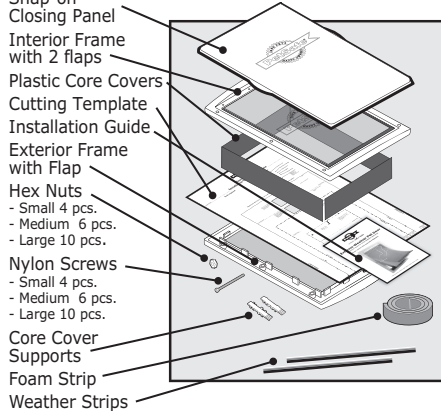

Tools Needed

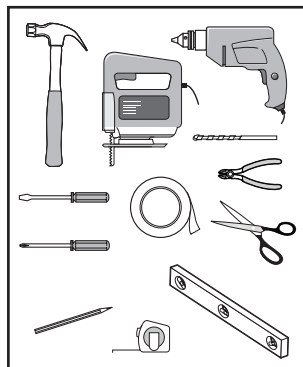

- Hammer
- Jigsaw
- Drill
- ½" Drill Bit
- Wire Cutters
- Slotted & Phillips Screwdrivers
- Tape Measure
- Tape
- Pencil
- Level
- Scissors
- Safety Equipment
- Optional**
- Duct Tape
- Caulk

NOTE: The Extreme Weather Pet Door™ can be installed in most doors and walls. Installation in thinner or thicker applications may not require the Plastic Core Covers. If installing in a wall, reduce cut-out width by 1" for the Small and Medium. For the Large reduce cut-out width by 1" and cut-out height by 1". Additional tools and materials, such as wood framing, may be required.

Want Professional Installation Help?

Invisible Fence® Brand installers (where available) may come to your home and install your new PetSafe® Pet Door for an additional cost. Contact the Customer Care Center at **1-877-866-DOGS (3647)** or visit the website at www.invisiblefence.com for more information.

Key Definitions

- **Outer Frame Size:** Overall pet door dimensions
- **Cut-Out Size:** Opening cut in homeowner's door for proper fit and pet door installation
- **Replacement Flap Size:** Overall flap size when removed from pet door. During extreme changes in weather, vinyl flaps can shrink during cold months and stretch in warmer months
- **Flap Opening Size:** Usable flap size for pet to enter and exit through pet door
- **Interior Frame:** Pet door frame on the inside of home
- **Exterior Frame:** Pet door frame on the outside of home
- **Insulated Flap:** Yellow flap located behind the vinyl flap in the interior frame
- **Plastic Core Covers:** Plastic pieces that cover the cut-out or "core" of the homeowner's door
- **Snap-on Closing Panel:** Cover that snaps onto the pet door frame to close the pet door opening

Installation Instructions

NOTICE

If painting the pet door, it is recommended to paint it prior to installation. For best results, use a primer for plastics before applying paint.

Step 1 Determine Pet Door Location

1

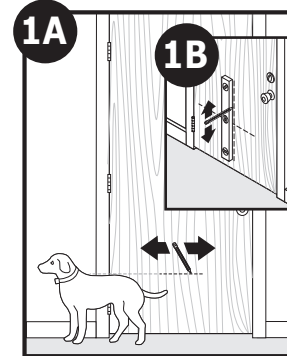

1A Measure and mark your pet's shoulder height on the interior side of door.

1B Determine location for the pet door. Draw a vertical center line through the shoulder height line using a level.

NOTICE

If homeowner's door or other application is not level, the pet door must be marked level to swing properly.

Step 2 Prepare Door

2

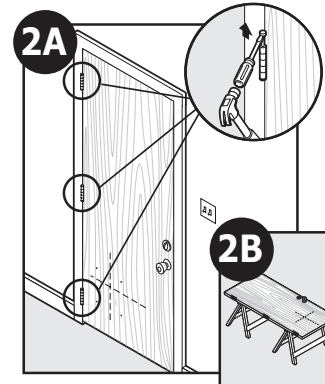

2A Remove door by removing door hinge pins.

2B Place on a raised level surface such as saw horses. Place interior side of door facing up.

Helpful Tip: Clamp down the door to prevent it from moving.

Note: The Pet Door can be installed with the door hanging based on your skill level.

2C Cut out the correct size template. Match the marked lines on the door with the shoulder and center lines on the template. Tape the template in place and carefully trace template. Make sure to trace underneath tape and connect the corners. Now, remove the template and any excess tape from the door.

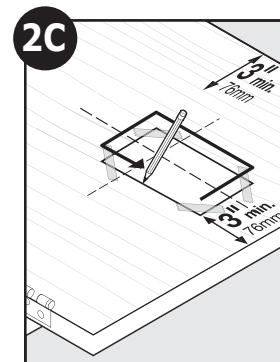

NOTICE

Cut out correct size template. For the Large, no cutting is required. If installing in a wall, reduce cut-out width by 1" for the Small and Medium. For the Large reduce cut-out width by 1" and cut-out height by 1".

NOTICE

When applying cutting template there should be a minimum of 3" between the bottom and sides of the door and the outer edge of the cutting template to maintain the structural integrity of the door.

Step 3 Cut Pet Door Opening

3

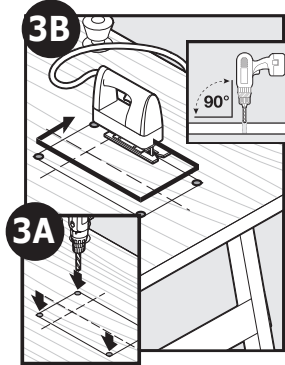

3A Drill $\frac{1}{2}$ " holes in inside corners of drawn template. These will be the pilot holes for the saw blade.

Helpful Tip: Use both hands to hold drill steady and straight at a 90° angle.

3B Beginning in one of the holes just drilled, cut along the drawn template lines. After cutting out the opening, you may need to recut to square the opening. This is necessary for the pet door frame to fit correctly.

Helpful Tip: Use proper saw blade length and type according to door thickness and material (for example a wood blade for a wood door and a metal blade for a metal door). Cut slowly using both hands to hold the saw steady and straight at a 90° angle. This will prevent the blade from cutting unevenly between interior and exterior sides of the door.

NOTICE

Make sure there is nothing underneath the door where you will be drilling the holes or cutting out opening.

Step 4 Fit Core Covers

4

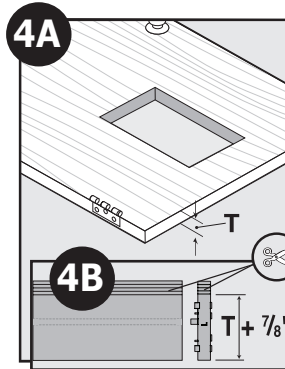

4A Measure the thickness (T) of your door. Note this measurement.

4B Cut the grooved side of the plastic core covers and core cover supports to equal the thickness (T) of your door + $\frac{1}{8}$ ".

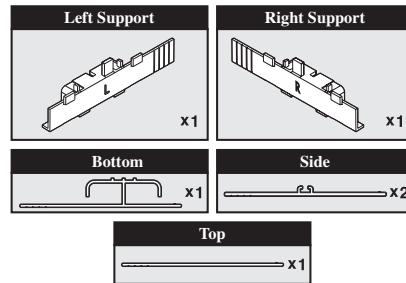

4C Place cut edge of bottom core cover toward you with ribbed side facing up. Snap left core cover support into left end of "T"-shaped rib on bottom core cover. Snap right core cover support into right end of "T"-shaped rib on bottom core cover. With channel sides facing in, align uncut edge (side with one rib) of side core covers with uncut edge of core cover supports. Slide channel of side core covers onto tab of core cover supports to form a "U"-shape.

4D Slide weather strips into channels of side core covers. Weather strips should face inside. Weather strips may need trimming to meet at end of side core covers.

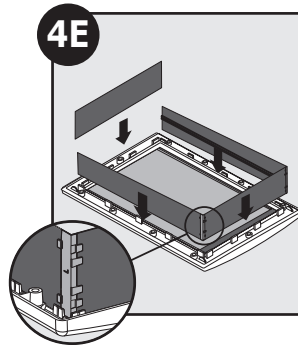
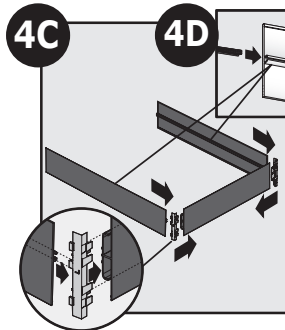

4E Snap uncut edge (side with one rib) of assembled core covers inside bottom and side tabs of interior frame (frame with 2 flaps). The bottom core cover should be at bottom of interior frame. Weather strips and ribbed sides (uncut edges) should face flap. Snap the uncut edge (side with one rib) of top core cover inside top tabs of interior frame. Uncut edge (side with one rib) of top core cover should face flap. Core covers may need trimming to meet at corners.



Optional: Use duct tape in the corners of core covers to help secure in place and to improve weather resistance. Cut off any excess tape.

Step 5 Install Pet Door

5

Fit

Check Before putting away jigsaw, place the exterior frame (frame with 1 flap) into the underside of the opening to check the fit. If the screw holes on frame are not visible through cut-out, you may need to recut opening before proceeding with the installation.

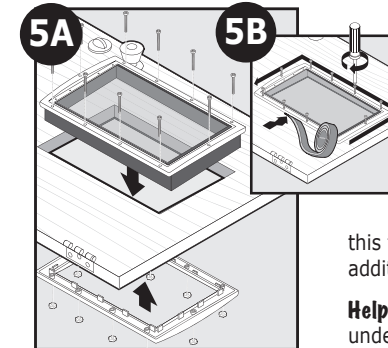

5A Place interior frame (frame with 2 flaps) into cut-out. Next place exterior frame into cut-out from under side of door, inserting core covers inside tabs of frame. Hold frame together. Insert nylon screws through holes in interior frame into holes in exterior frame. Thread a hex nut onto bottom of each screw.

5B Start screws, but do not tighten at this time. Place foam strip under interior frame for additional insulation. Cut off any excess.

Helpful Tip: Use a screwdriver to tuck the foam strip under as you work around the frame.

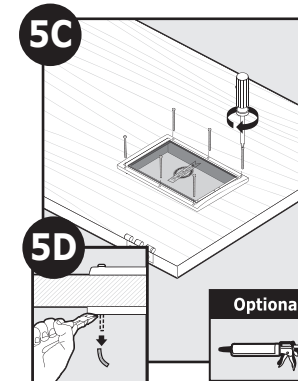

5C Use a screwdriver to evenly tighten screws through-out frame while keeping core covers in position. It may be necessary to adjust screws to make sure pet door fit is correct.

Helpful Tip: Look though flap opening to check if core covers are in position as you tighten the screws.

5D Use wire cutters to trim screws flush with exterior frame.

NOTICE

Use a manual screwdriver to tighten screws. Do not overtighten. Overtightening can strip the screws or warp the pet door frame.

Optional: Caulk around the exterior frame (frame with one flap) and inside threshold where core covers meet for weather resistance.

Step 6 Train Your Pet

6

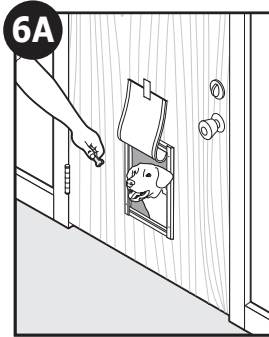

6A Rehang your door and begin training your pet. It may help for you to be on one side of the door and your pet on the other. Lift or tape open flap and try to talk your pet through the pet door. After your pet has gone through a few times, allow the flap to touch your pet's back so they will become comfortable using the pet door. If your pet will not go through the door, tape the flap open until they use it on their own.

Helpful Tip: Try treats or toys to encourage your pet to go through the pet door and become comfortable using it.

Closing Panel

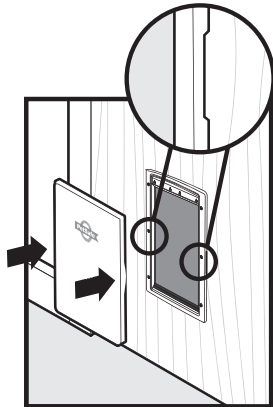

The Closing Panel snaps onto the interior frame of the Extreme Weather Pet Door™. It is useful during inclement weather or to keep your pet from using the pet door.



An additional closing panel (sold separately) can be used on the exterior frame of the Extreme Weather Pet Door™ for improved weather resistance. See "Replacement Parts and Accessories" on page 10.

Replacement Flaps

Vinyl Flap Replacement and Adjustment

During extreme changes in weather, vinyl flaps can shrink during cold months and expand in warmer months. Easily replace or adjust to ensure a snug fit during seasonal changes.

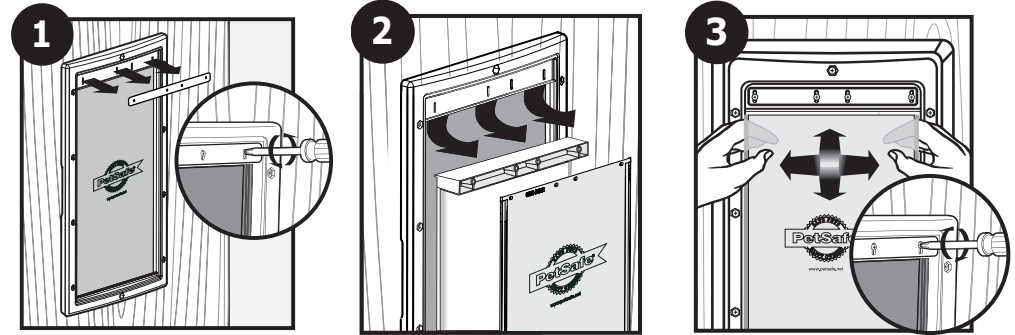

To Replace vinyl flap, remove flap screws and flap support from top of pet door frame.

Remove vinyl flap and flap clamp with attached insulated flap.

Replace flap clamp with attached insulated flap. Insert new vinyl flap between flap clamp and flap screw holes in top of frame. The PetSafe® logo should be readable on vinyl flap. Replace flap support. Align screw holes in flap support, frame, vinyl flap and flap clamp. Replace and start screws to hold flap in place. Adjust flap horizontally until centered in pet door frame. Adjust flap vertically until magnet bar on frame jumps to meet magnet on bottom of flap. Tighten screws.

Note: Interior flap has a flap support, exterior flap does not.

Note: Interior flap clamp has insulated flap attached, exterior flap clamp does not.

To Adjust slightly loosen flap screws on top of pet door frame.

Adjust flap horizontally until centered in pet door frame. Adjust flap vertically until magnet bar on frame jumps to meet magnet on bottom of flap. Tighten screws.

Insulated Flap Replacement

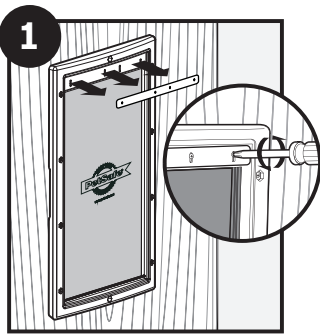

1 To replace the insulated flap, remove flap screws and flap support from top of pet door frame.

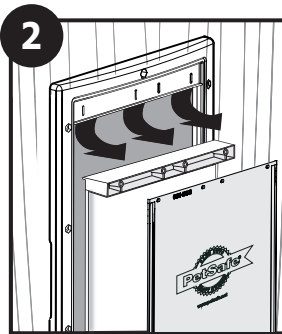

2 Remove vinyl flap and flap clamp with attached insulated flap.

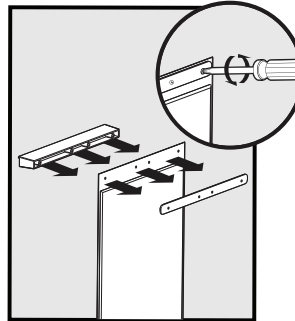

Remove screws, insulated flap and backing plate from back of flap clamp. Insert new insulated flap between flap clamp back and backing plate. Align screw holes. Replace and tighten screws. Follow step 3 under "Vinyl Flap Replacement and Adjustment" on page 9.

TERMS OF USE AND LIMITATIONS OF LIABILITY

- 1. Terms of Use-** This product is offered to you conditioned upon your acceptance without modifications of the terms, conditions and notices contained herein. Use of this product implies acceptance of all such terms, conditions and notices.
- 2. Proper Use-** This product is designed for use with pets where training is desired. The specific temperament of your pet may not work with this product. If you are unsure whether this is appropriate for your pet, please consult your veterinarian or certified trainer. Proper use includes reviewing the entire Installation Guide provided with your product including any specific safety information.
- 3. Limitations of Liability-** In no event shall Radio Systems® Corporation be liable for any direct, indirect, punitive, incidental, special or consequential damages whatsoever arising out of or connected with the use or misuse of this product. Buyer assumes all risks and liabilities from the use of this product.
- 4. Modifications of Terms and Conditions-** Radio Systems® Corporation reserves the right to change the terms, conditions and notices under which this product is offered.

Replacement Parts and Accessories

Replacement flaps can be purchased by visiting www.petsafe.net or by contacting our Customer Care Center at **1-800-732-2677**.

Part Description	Part Number
Small Vinyl Replacement Flap	PAC11-11037
Medium Vinyl Replacement Flap	PAC11-11038
Large Vinyl Replacement Flap	PAC11-11039
Small Insulated Replacement Flap Kit	MPA00-12817
Medium Insulated Replacement Flap Kit	MPA00-12818
Large Insulated Replacement Flap Kit	MPA00-12819
Small Snap-on Closing Panel	MPA00-12826
Medium Snap-on Closing Panel	MPA00-12827
Large Snap-on Closing Panel	MPA00-12828
Installation Hardware Kit	MPA00-11824
Small Plastic Core Cover Kit	MPA00-12664
Medium Plastic Core Cover Kit	MPA00-12665
Large Plastic Core Cover Kit	MPA00-12666

Radio Systems® Corporation

10427 PetSafe Way
Knoxville, TN 37932
1-800-732-2677
www.petsafe.net
400-1352

©2007 Radio Systems® Corporation